

zero

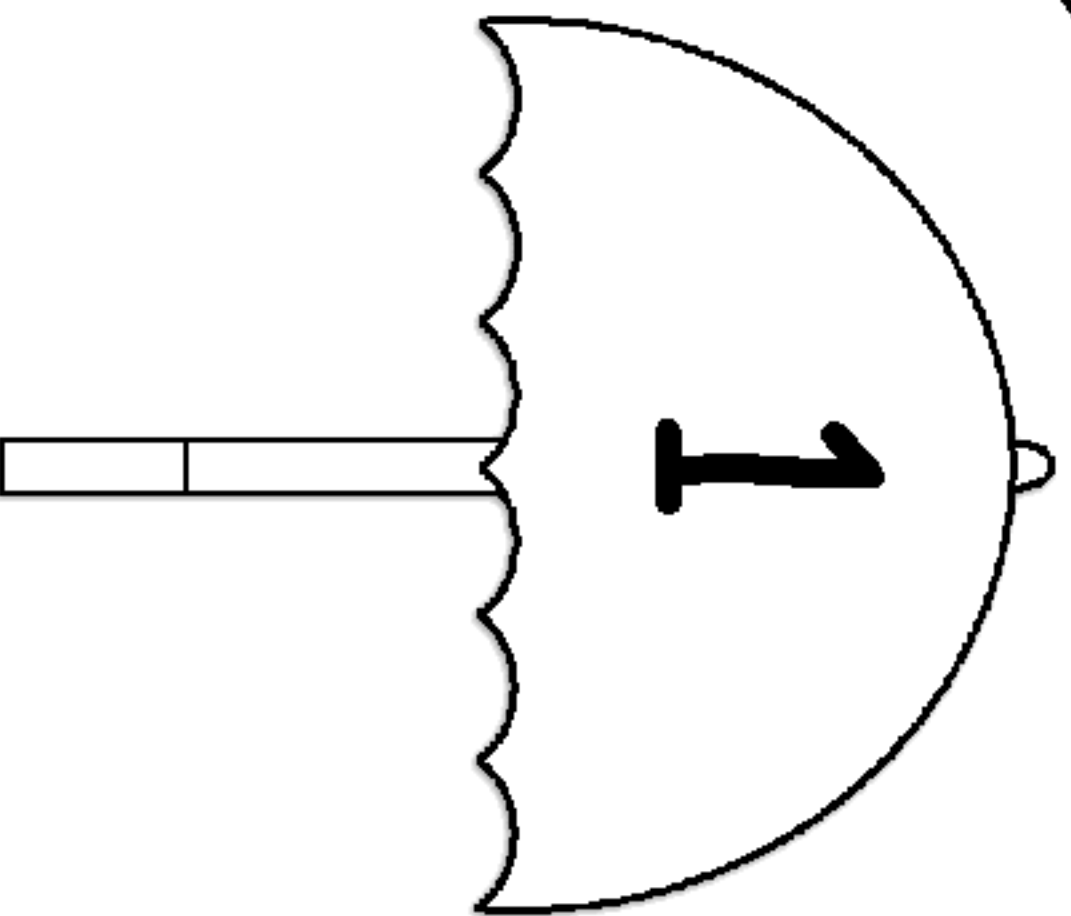

one

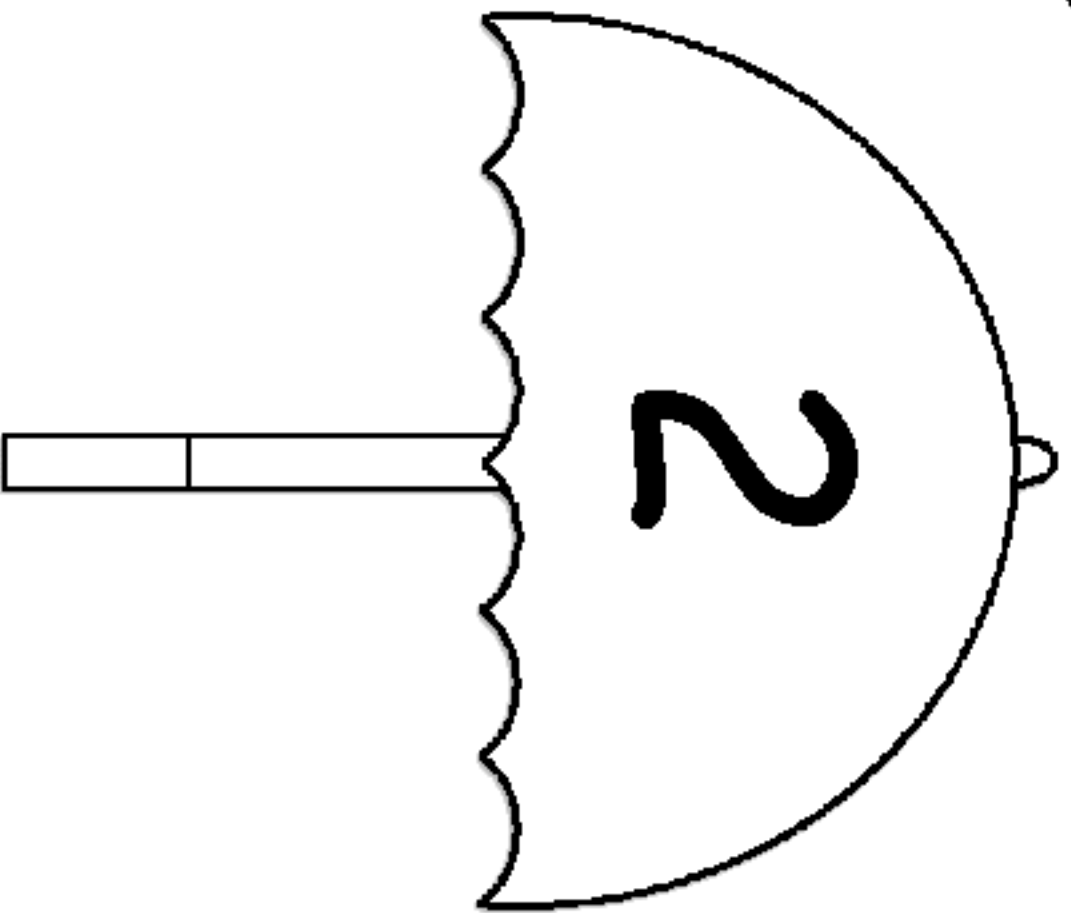

two

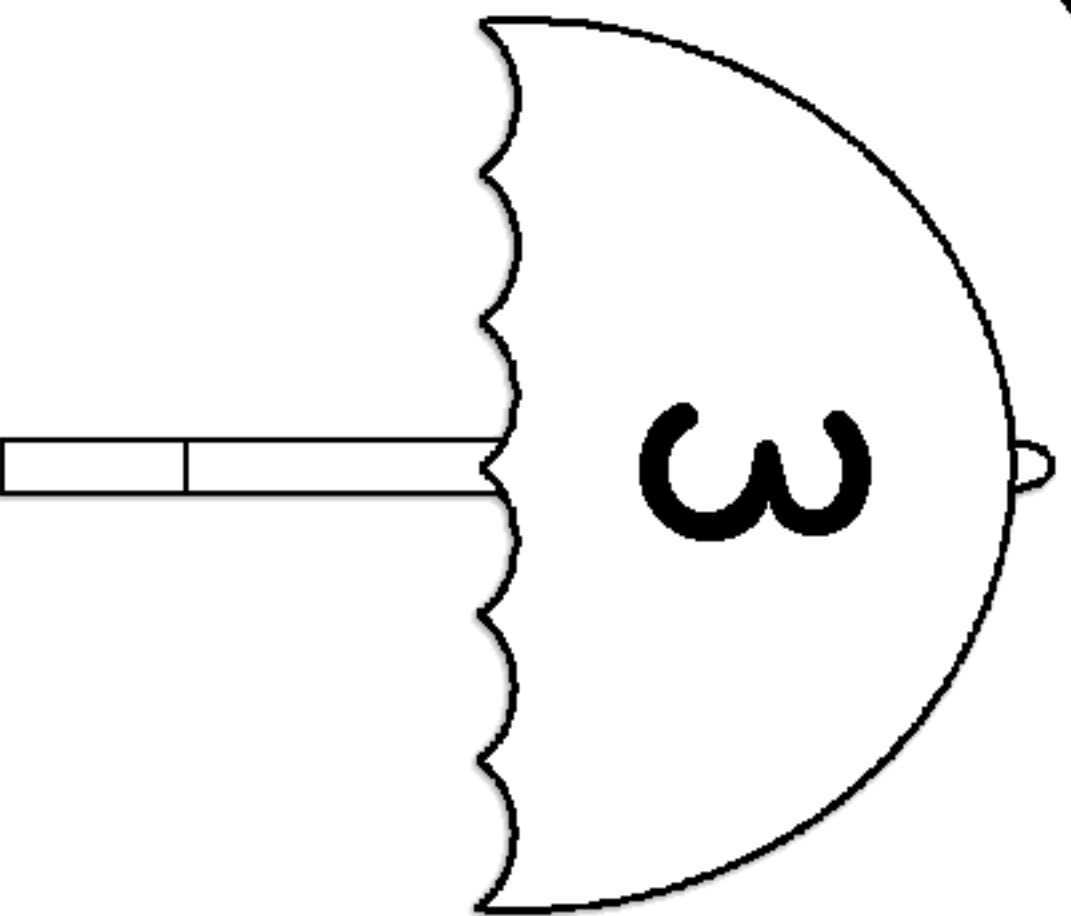

three

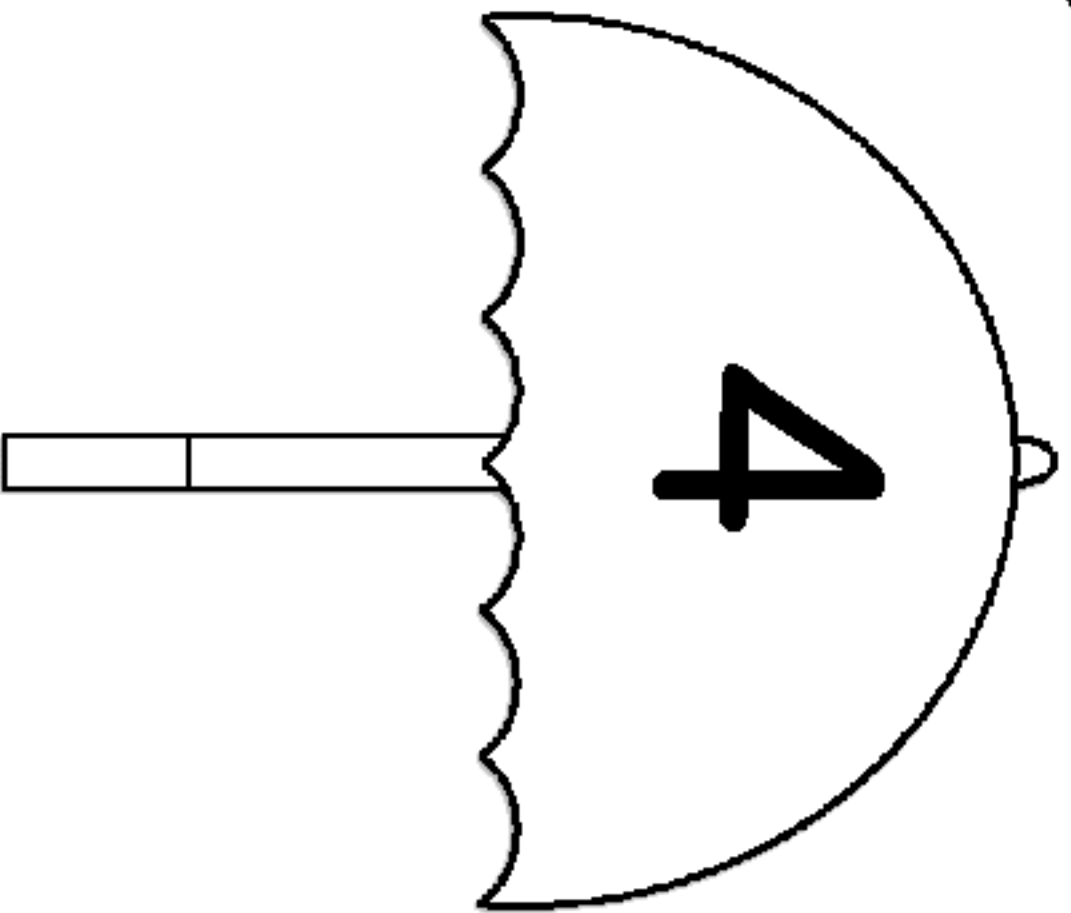

four

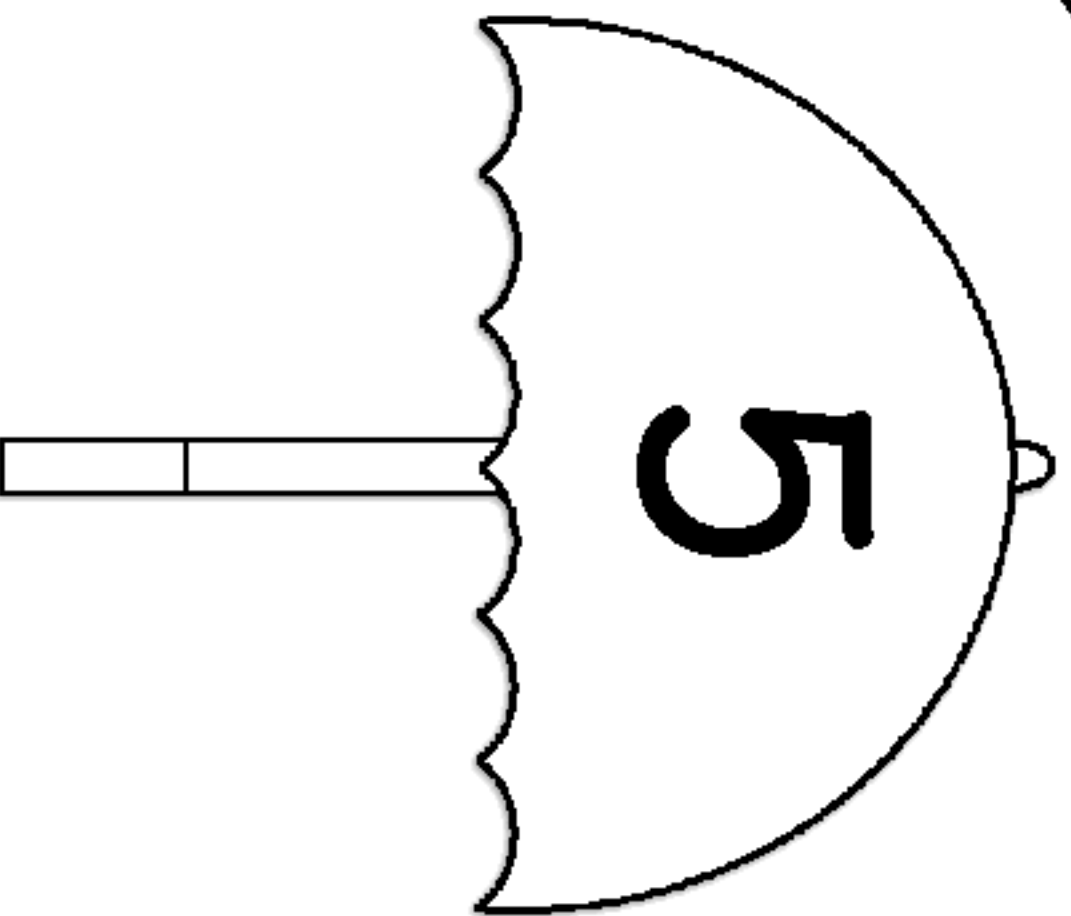

five

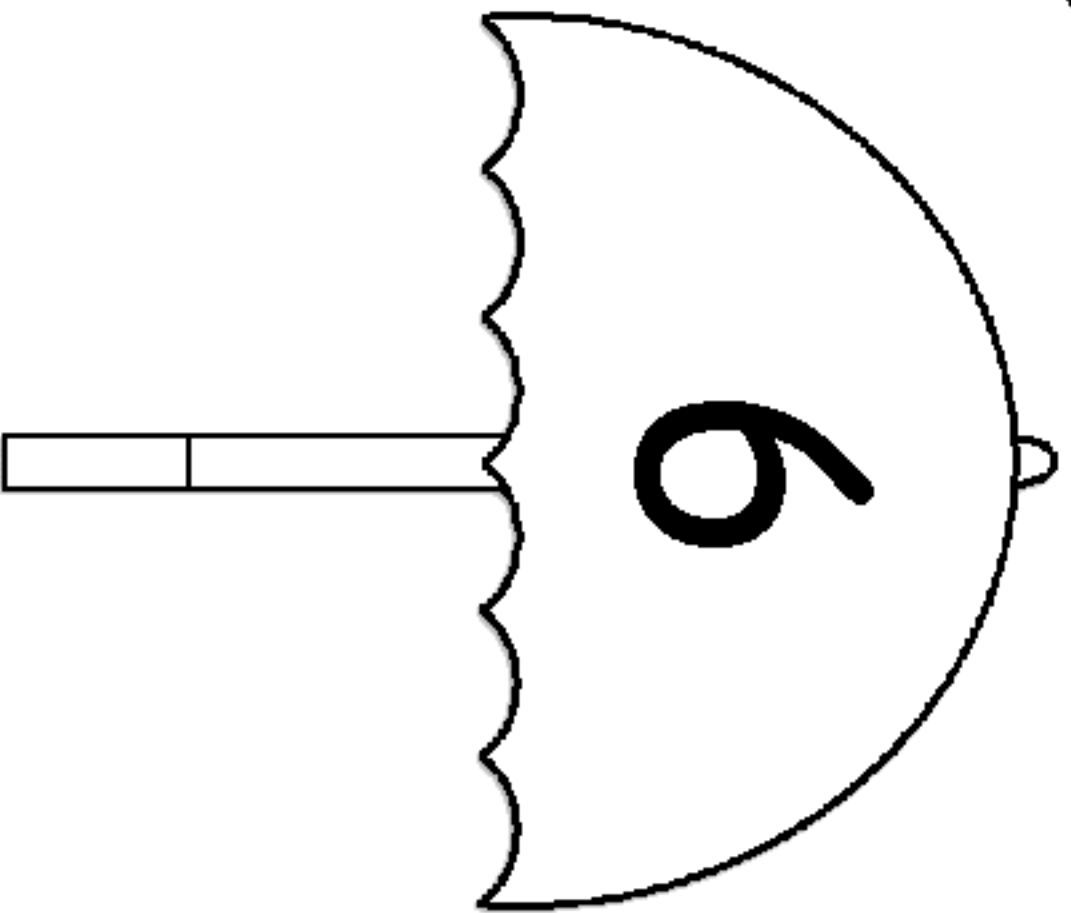

six

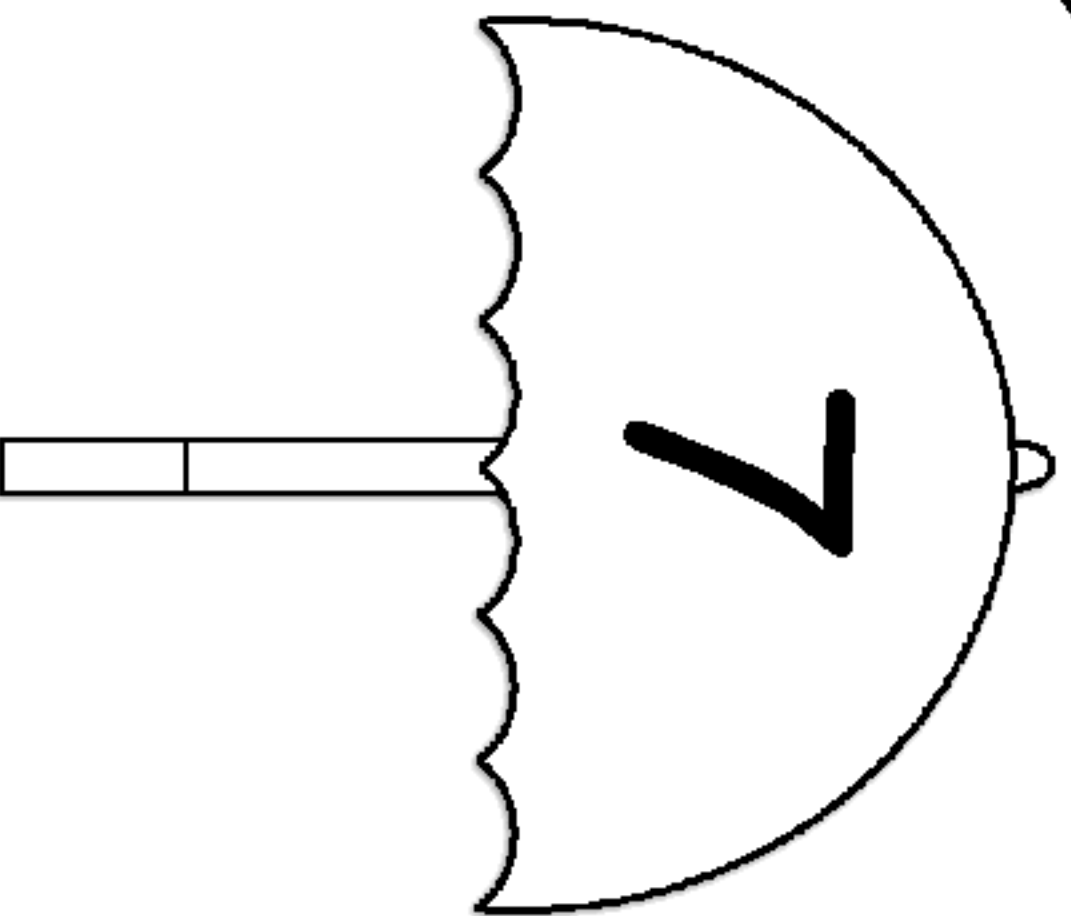

seven

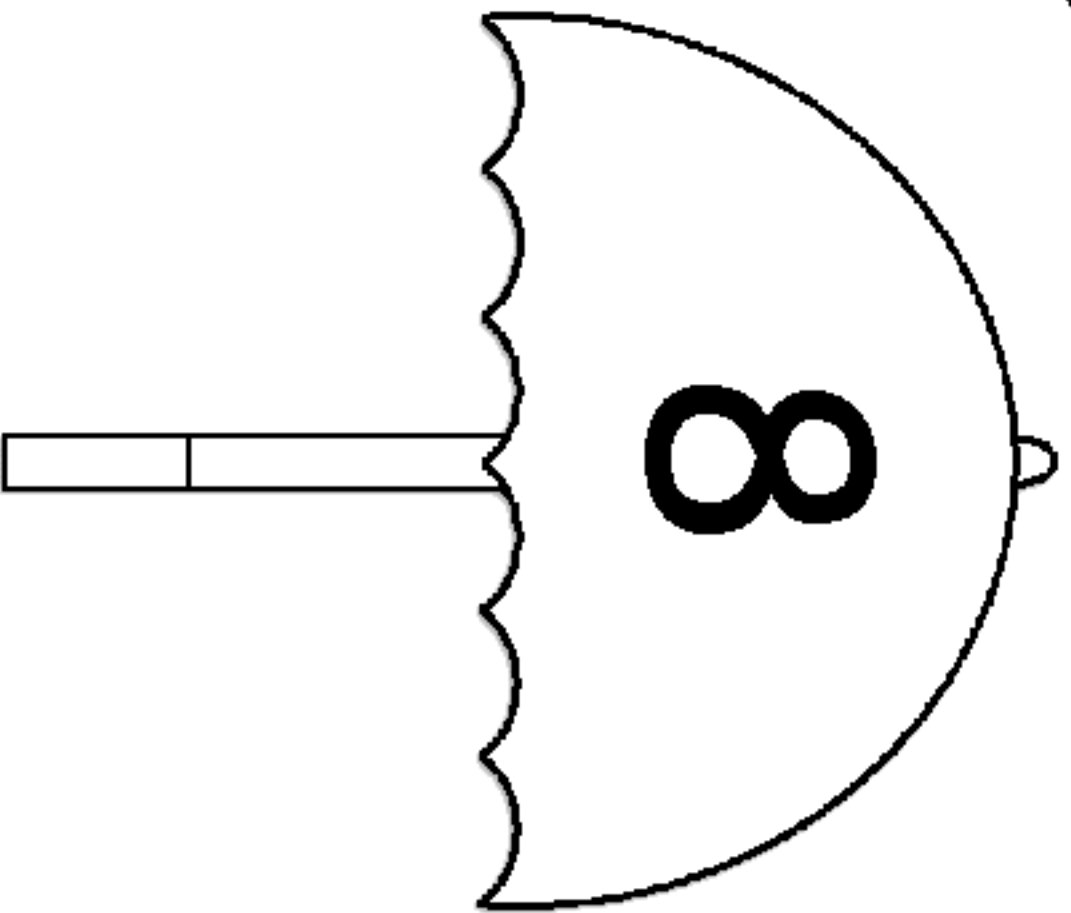

eight

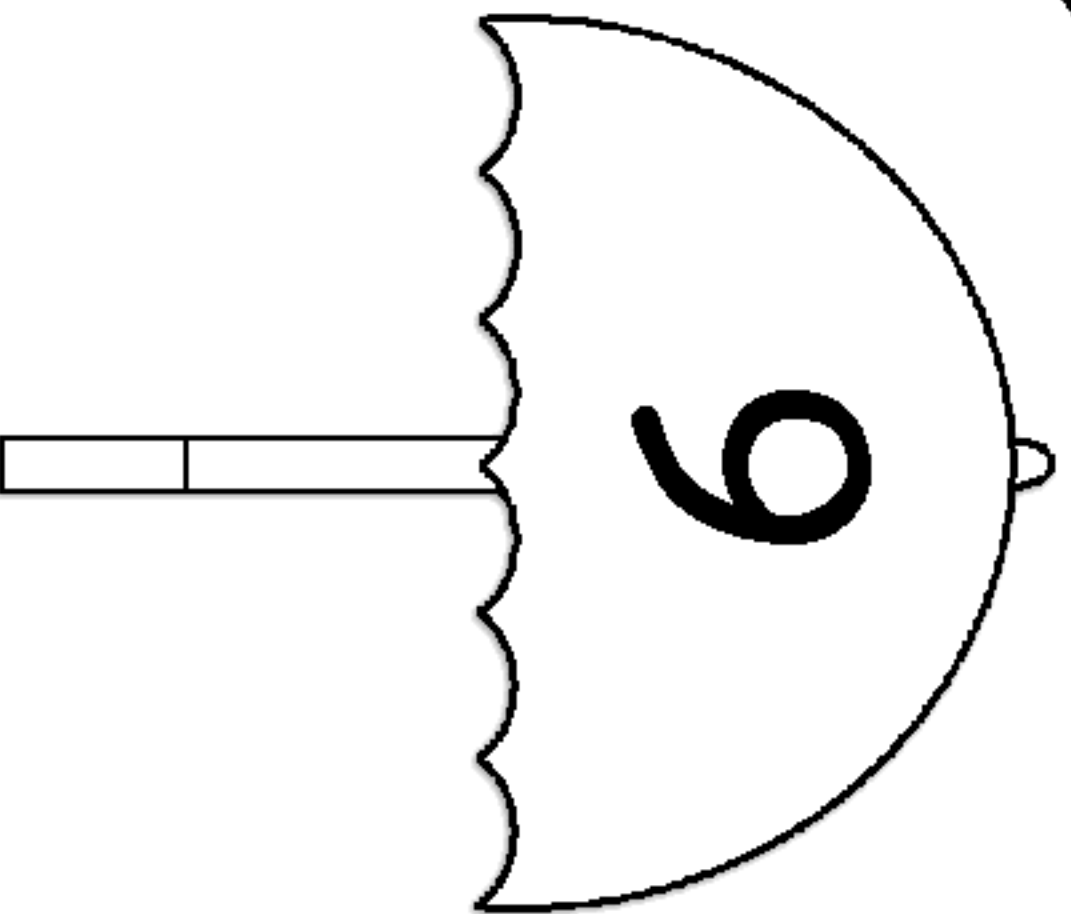

nine

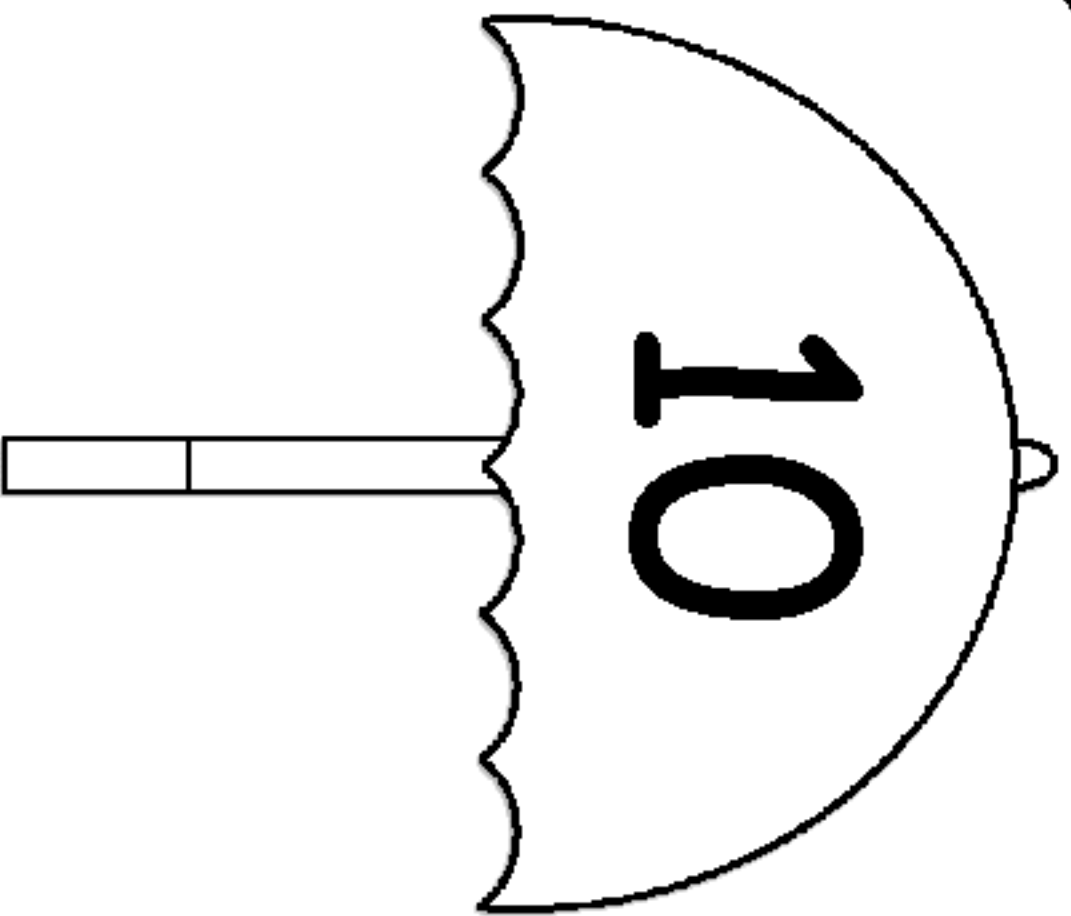

ten

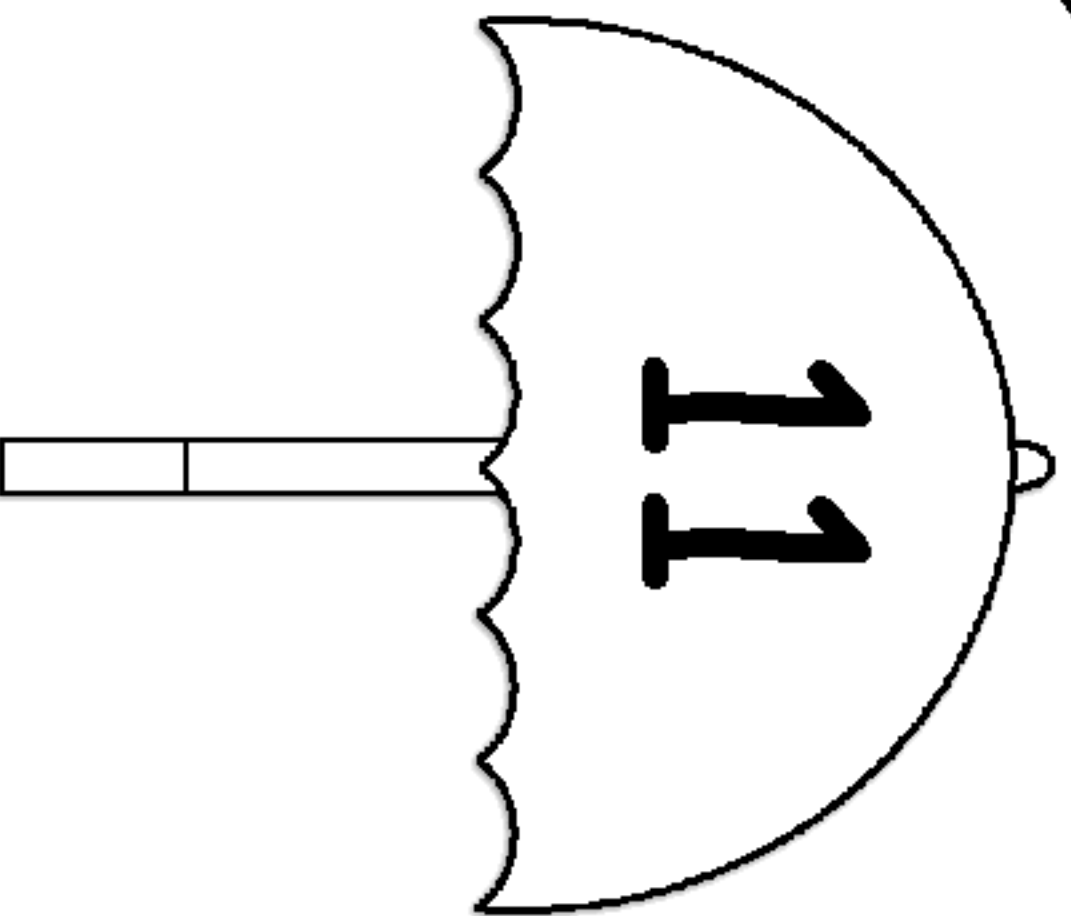

eleven

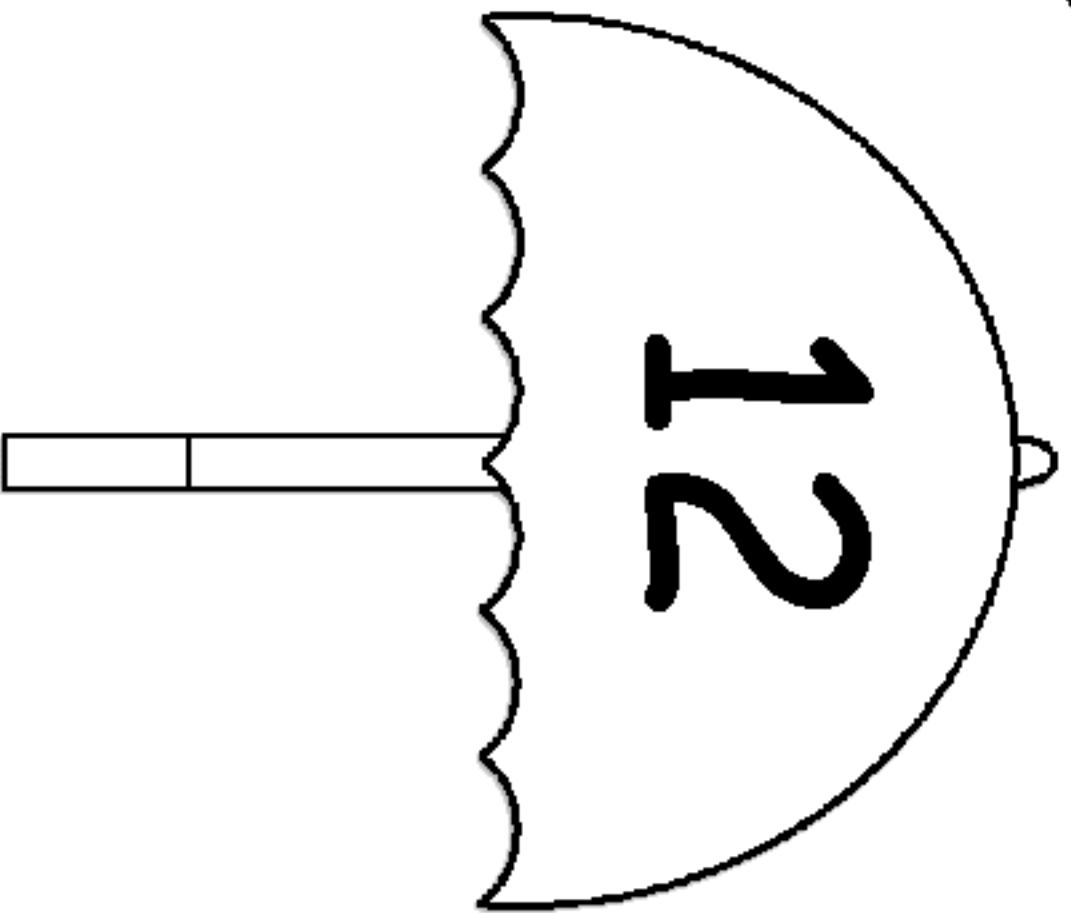

twelve

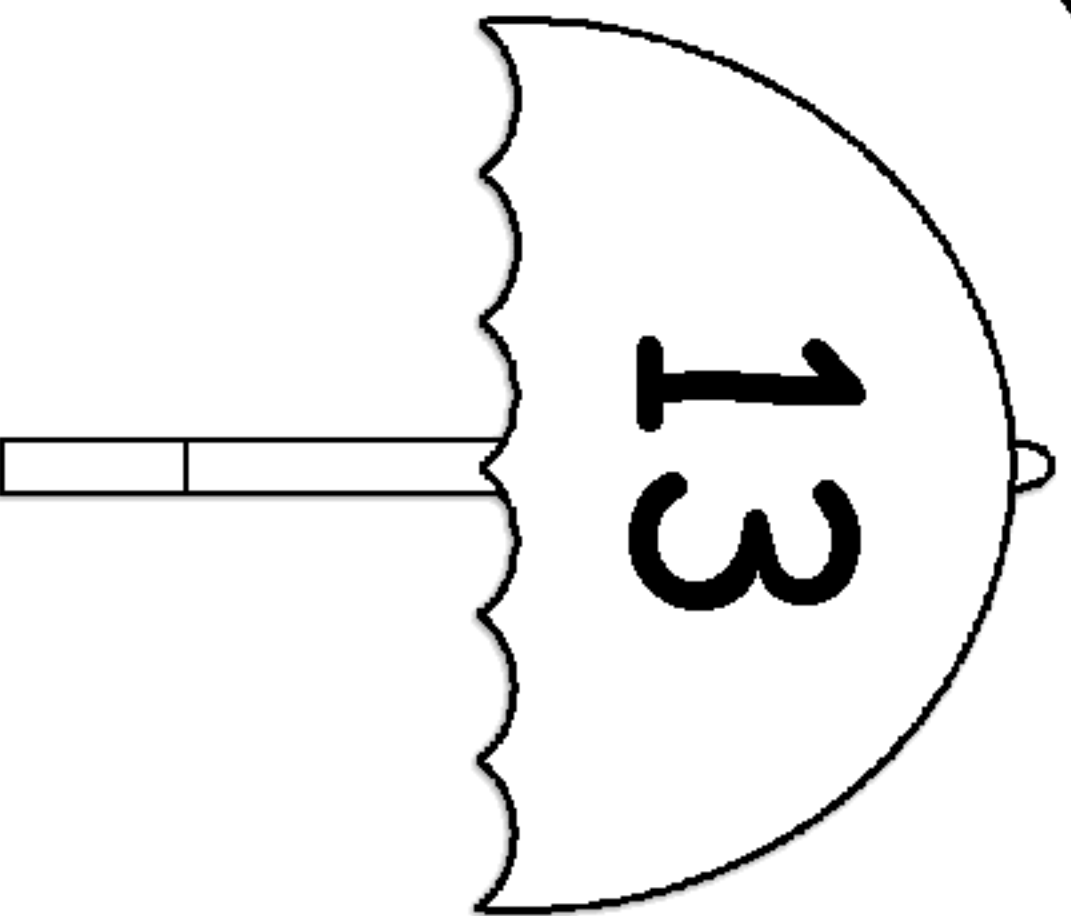

thirteen

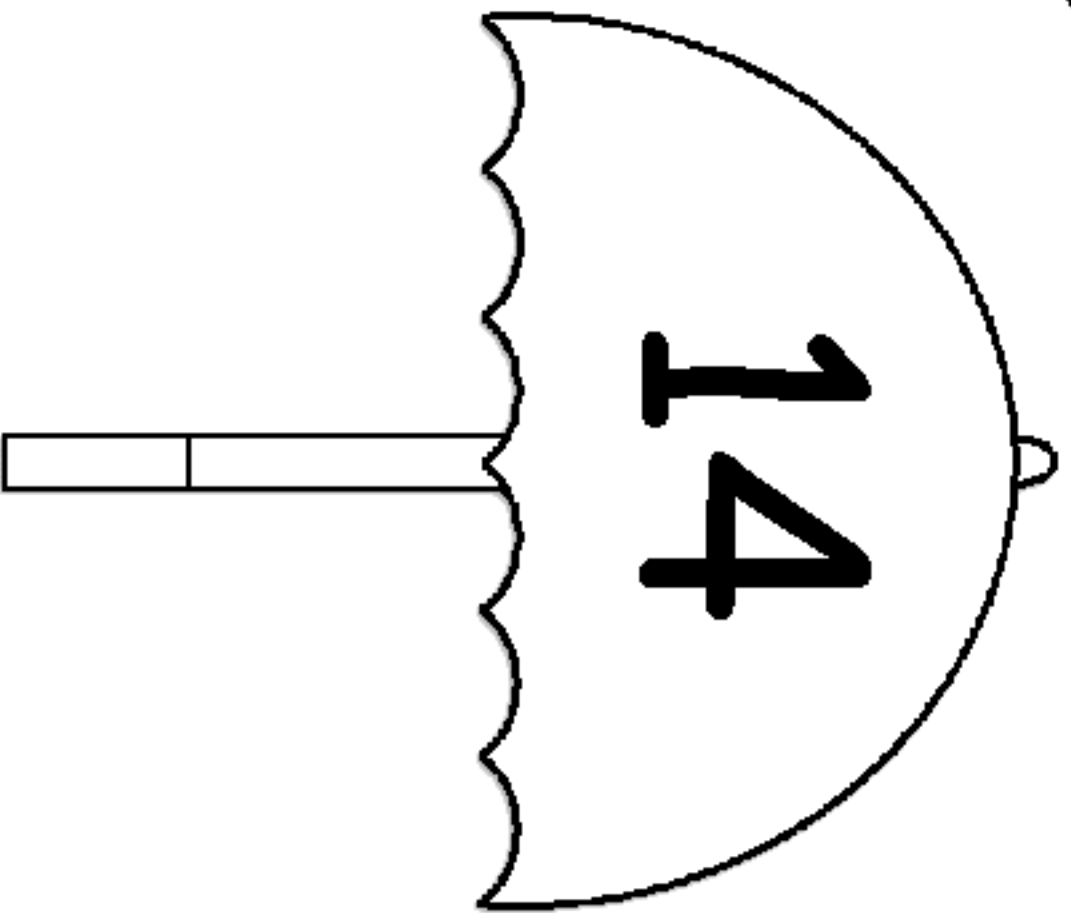

fourteen

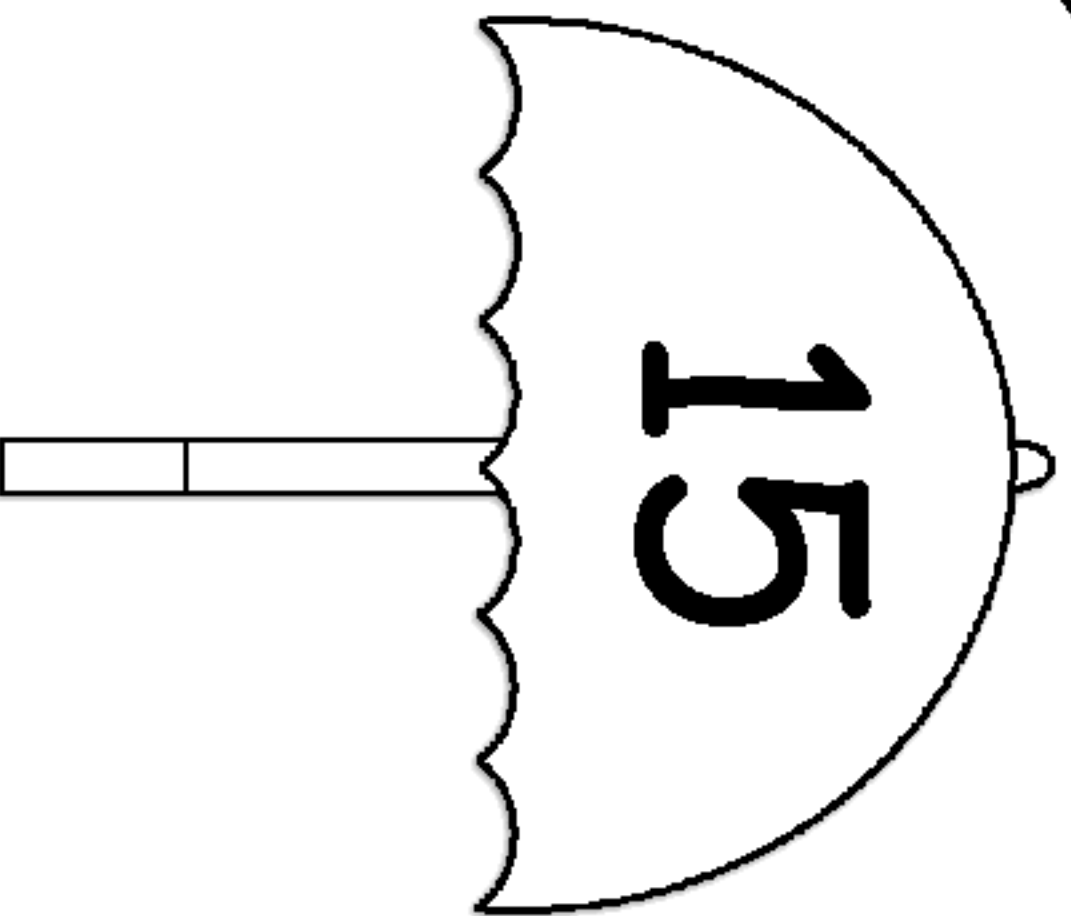

fifteen

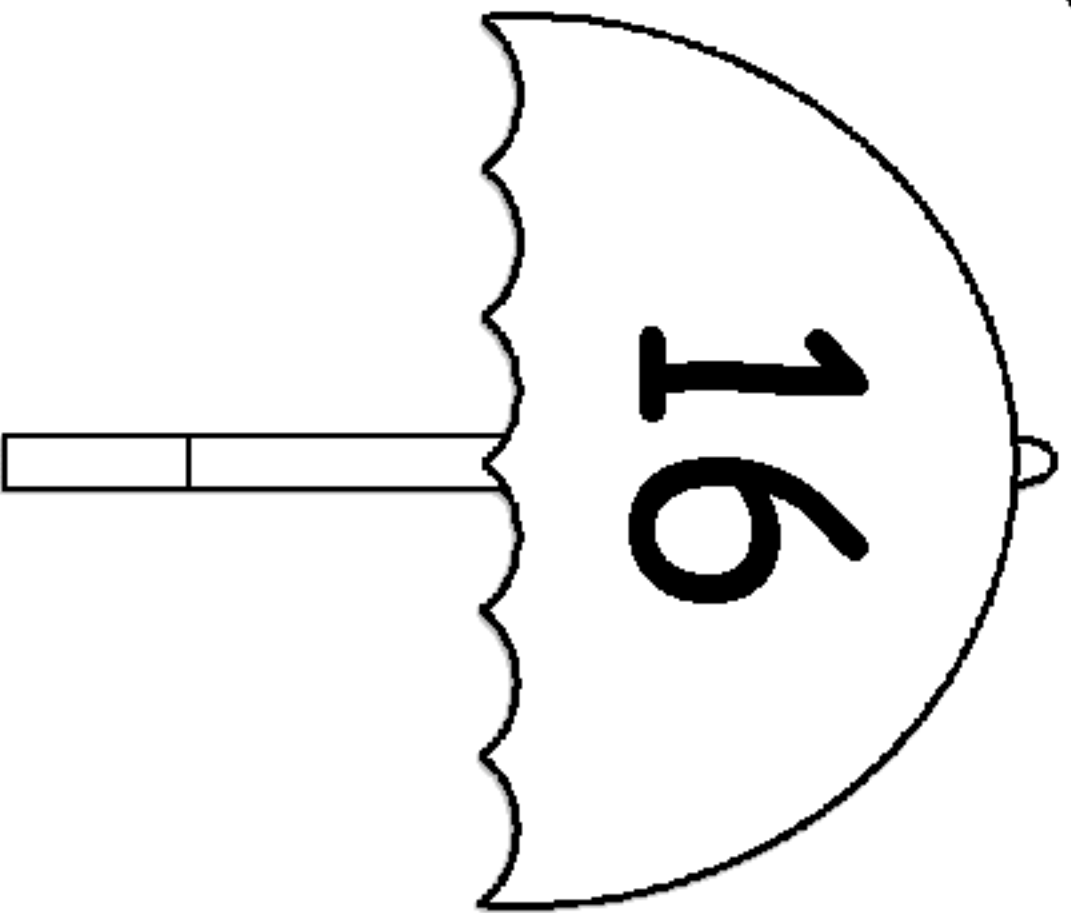

sixteen

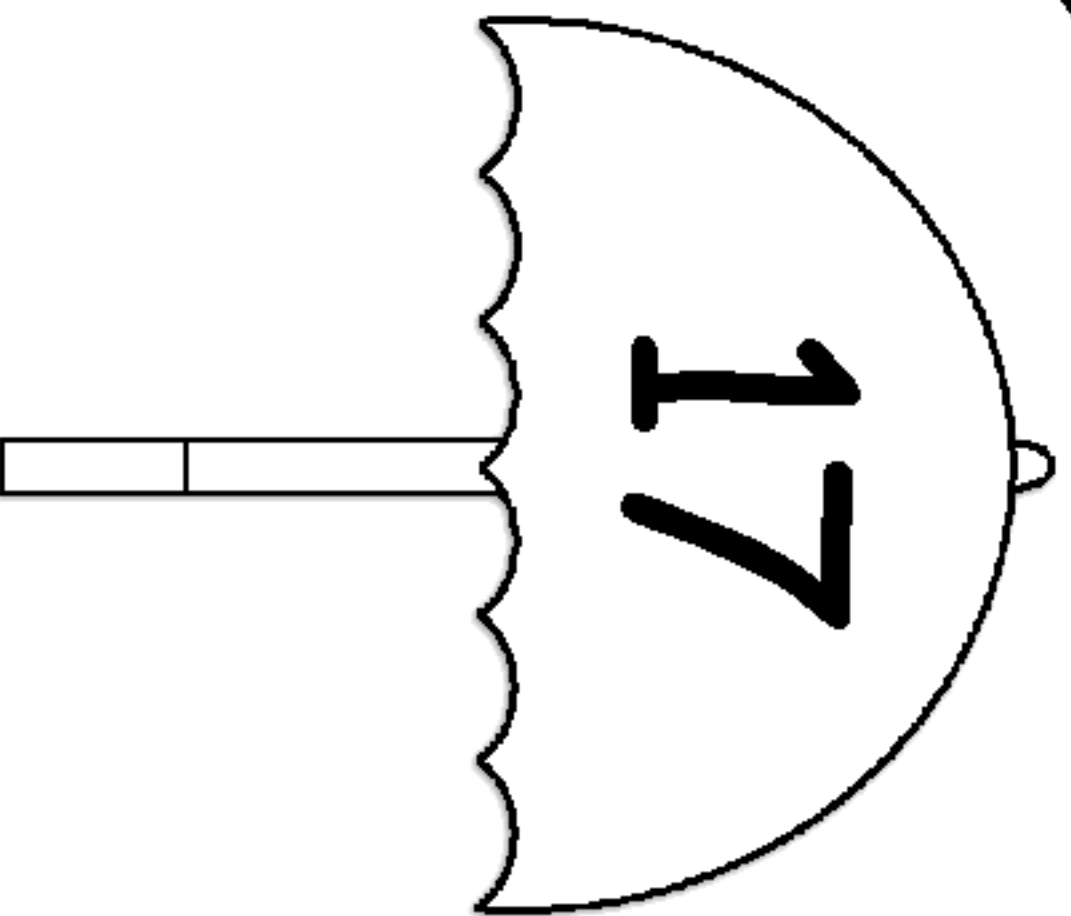

seventeen

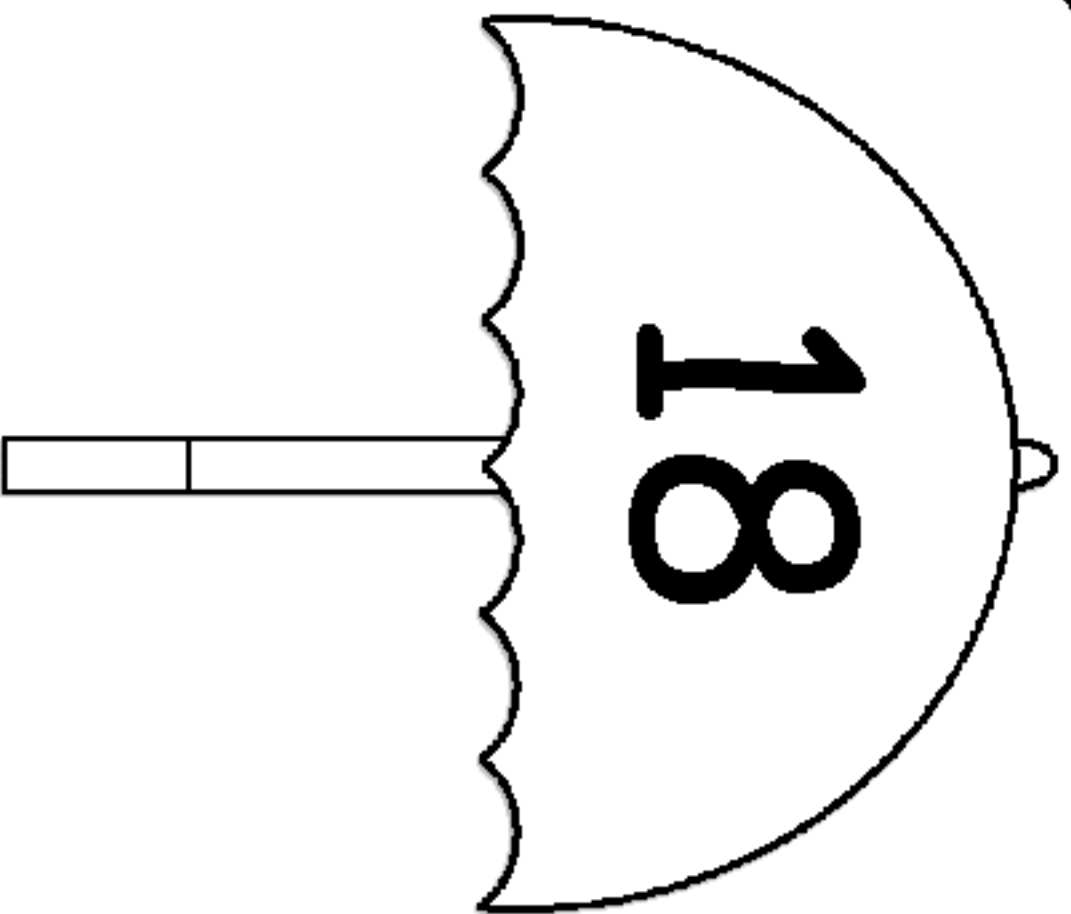

eighteen

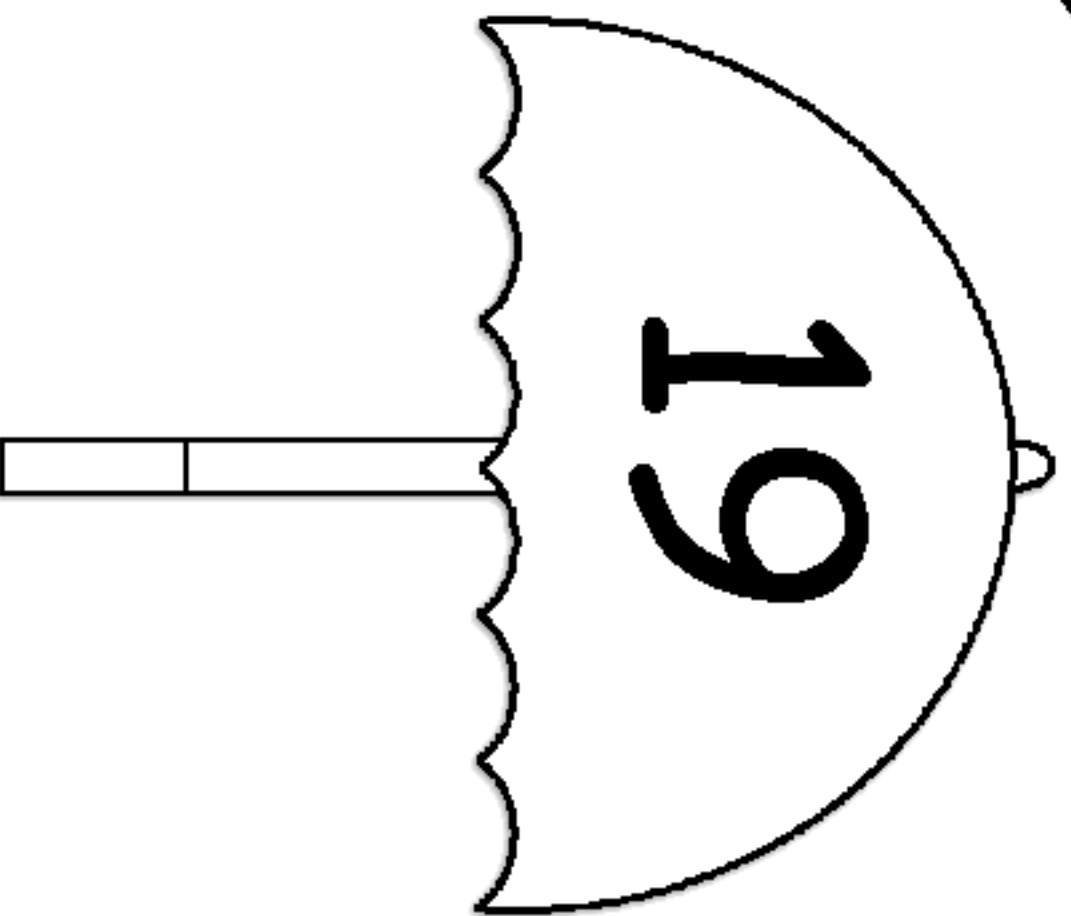

nineteen

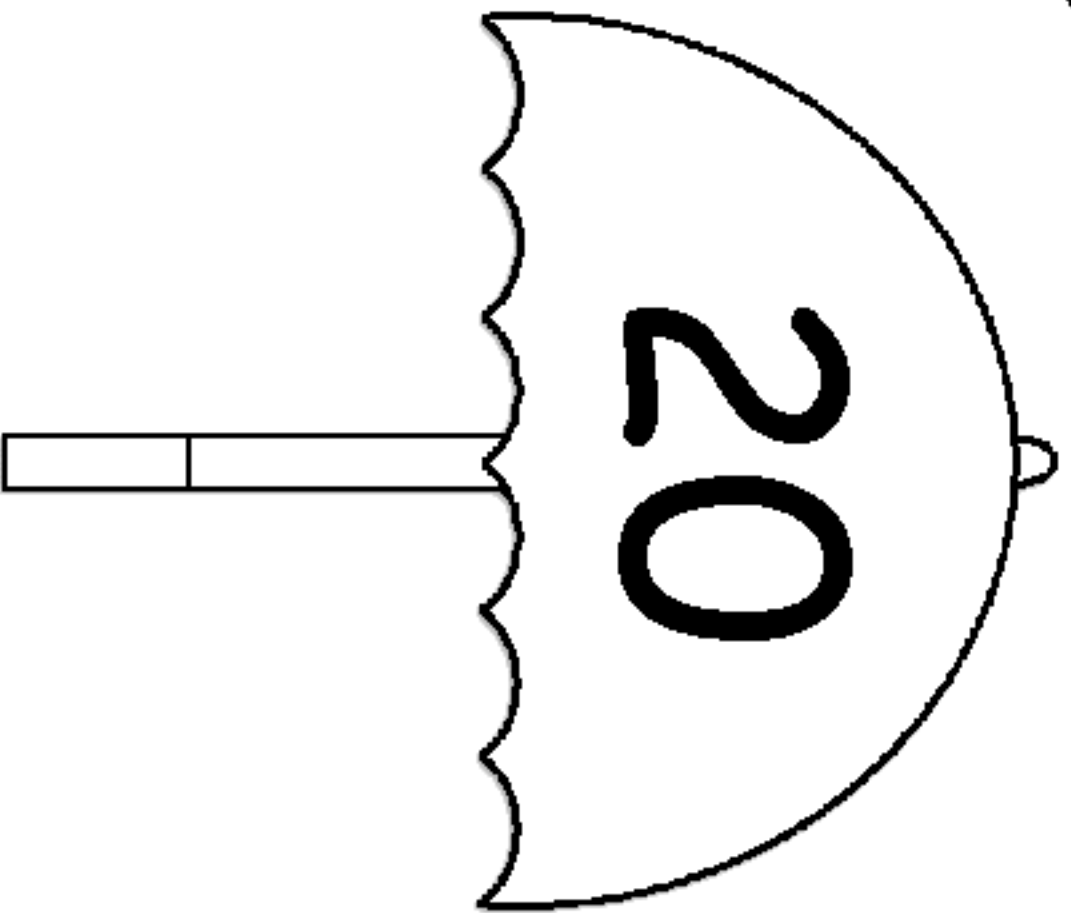

twenty

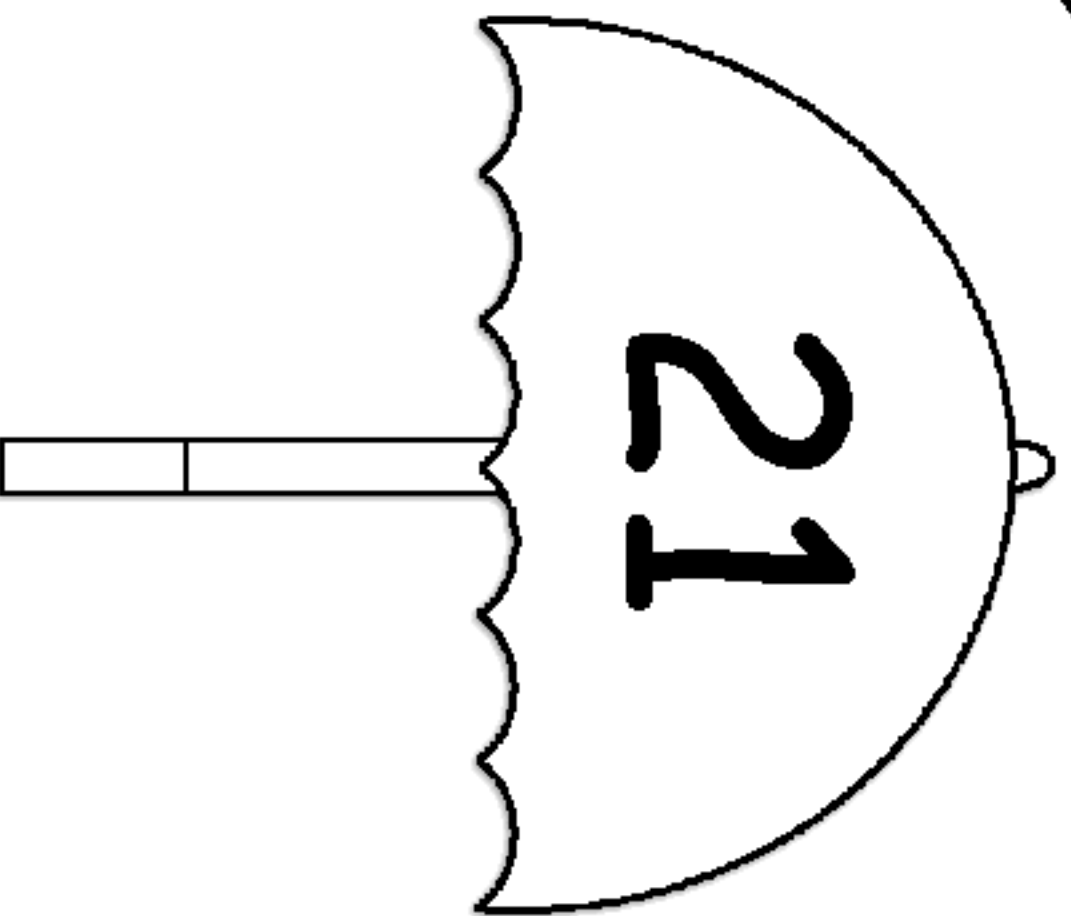

twenty one

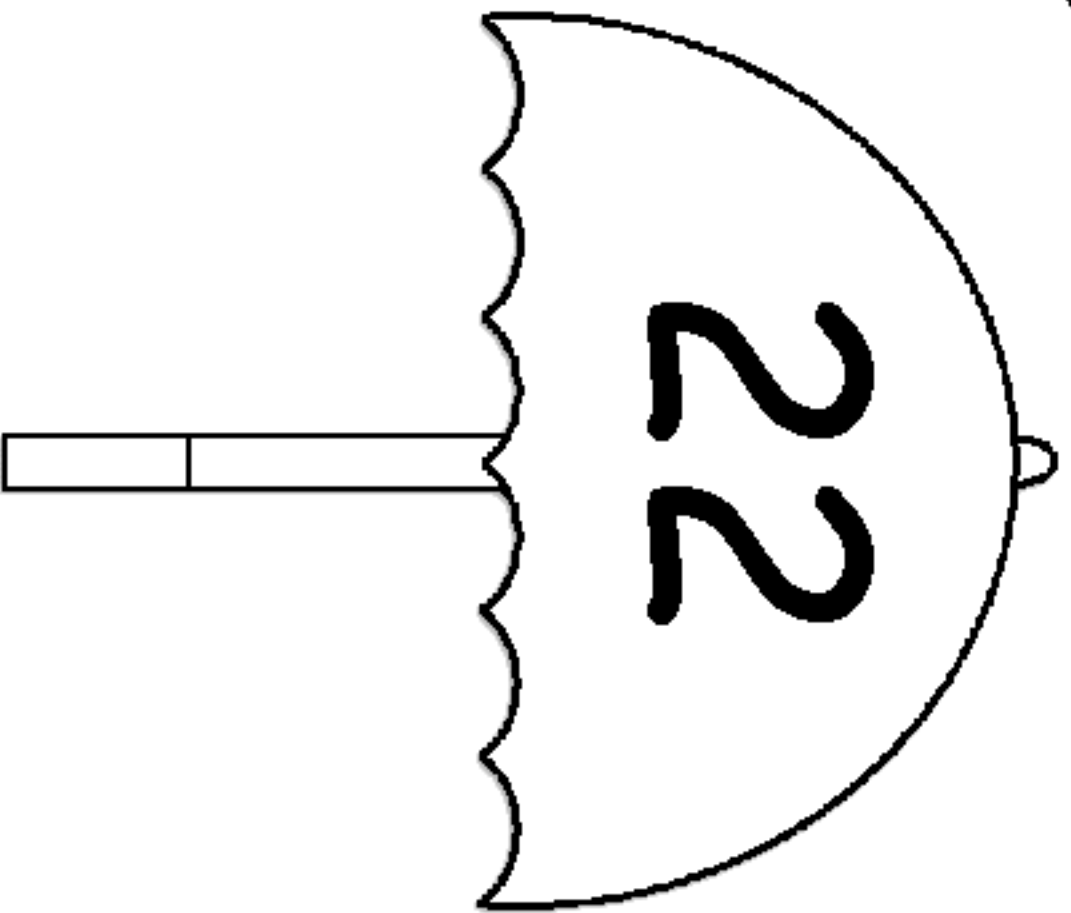

twenty two

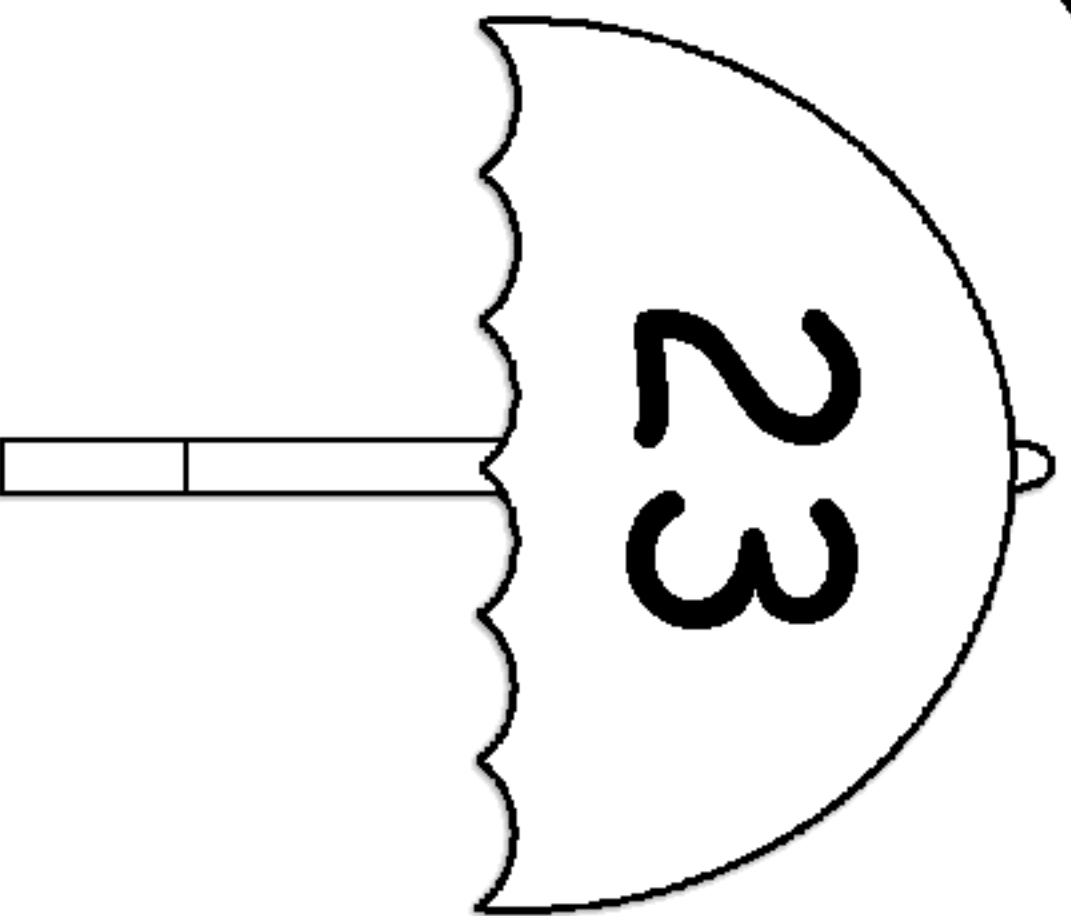

twenty three

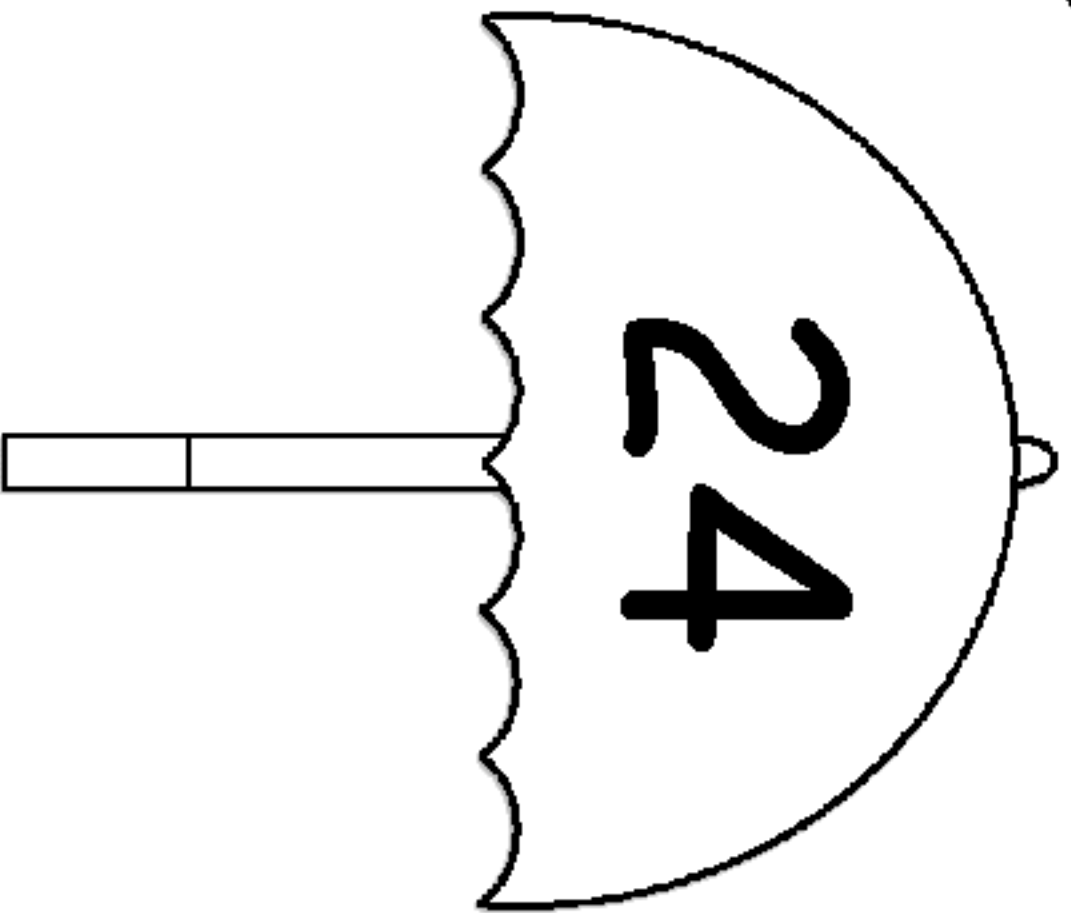

twenty four

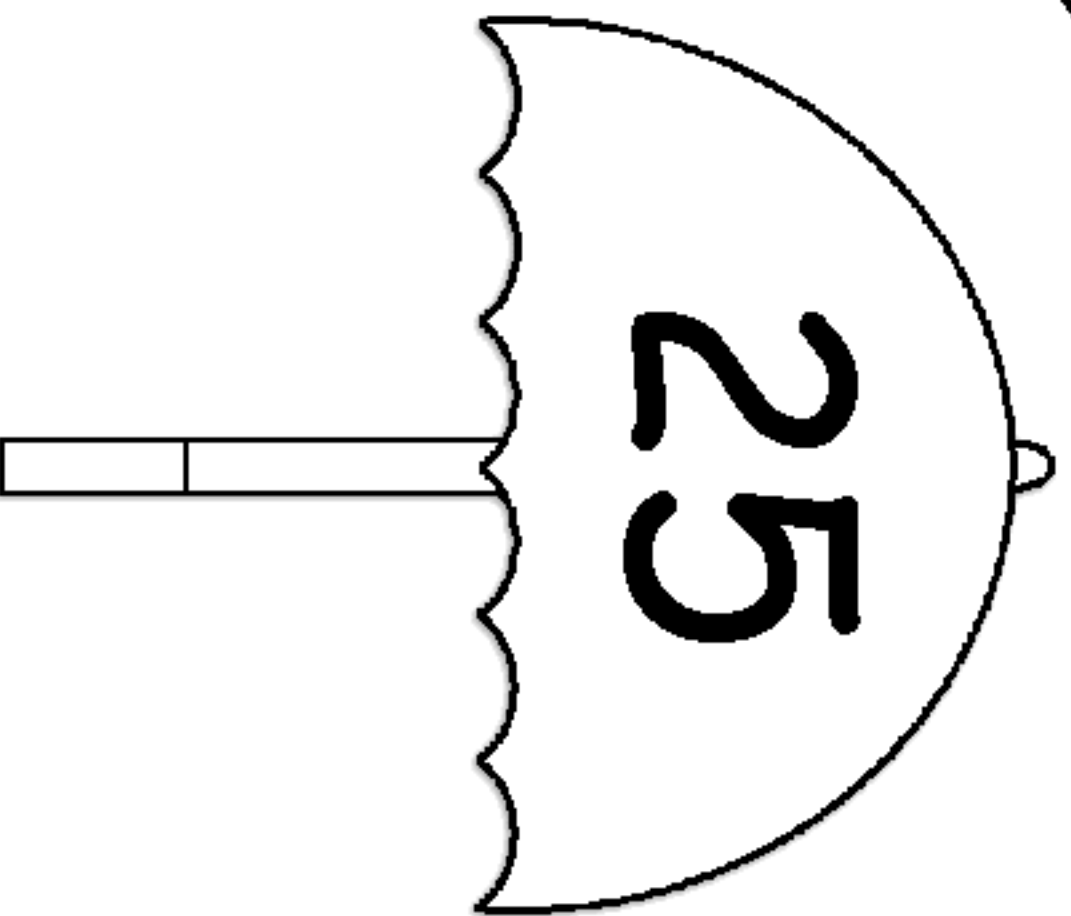

twenty five

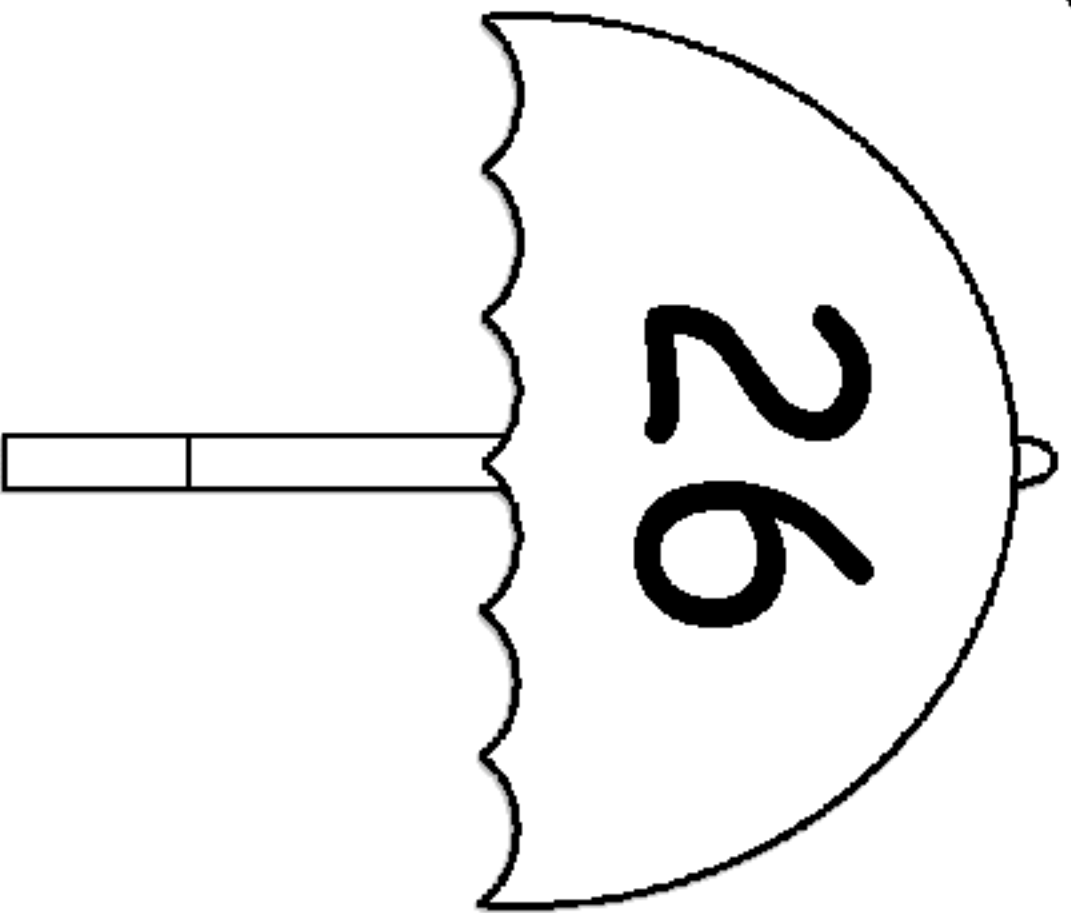

twenty six

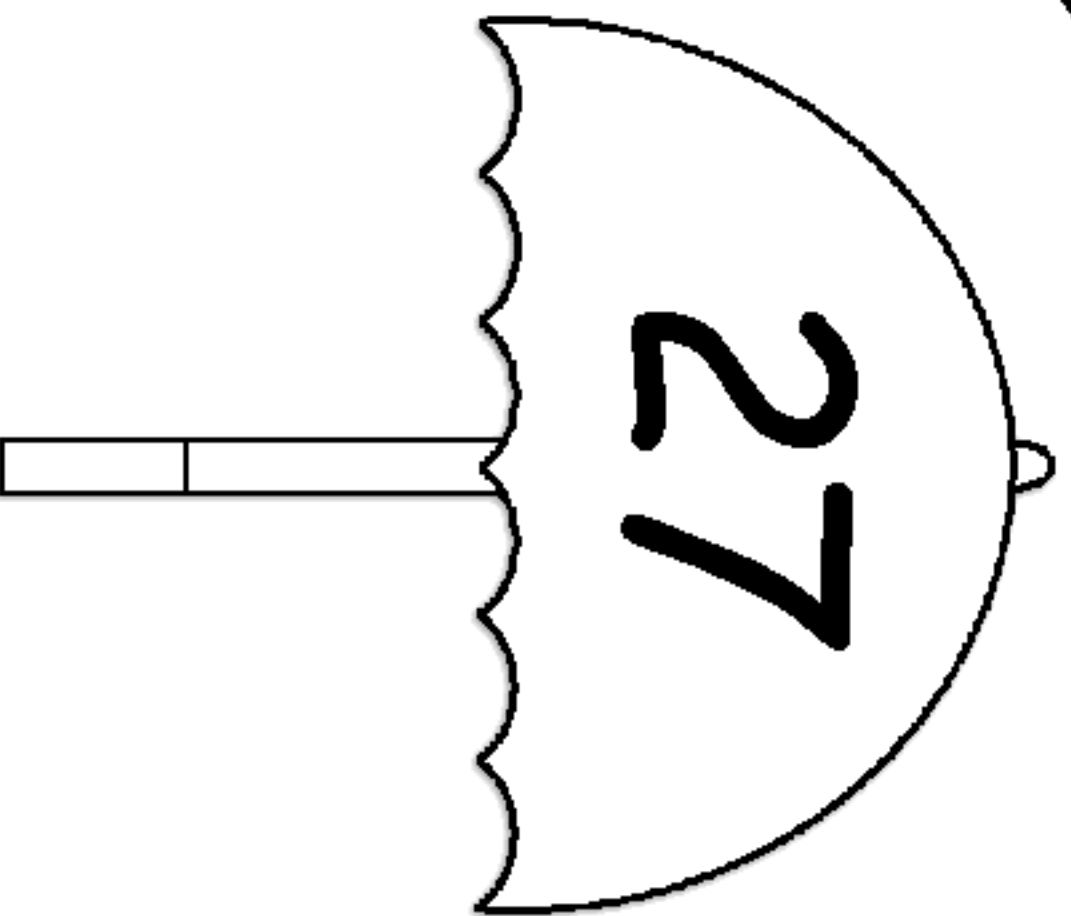

twenty seven

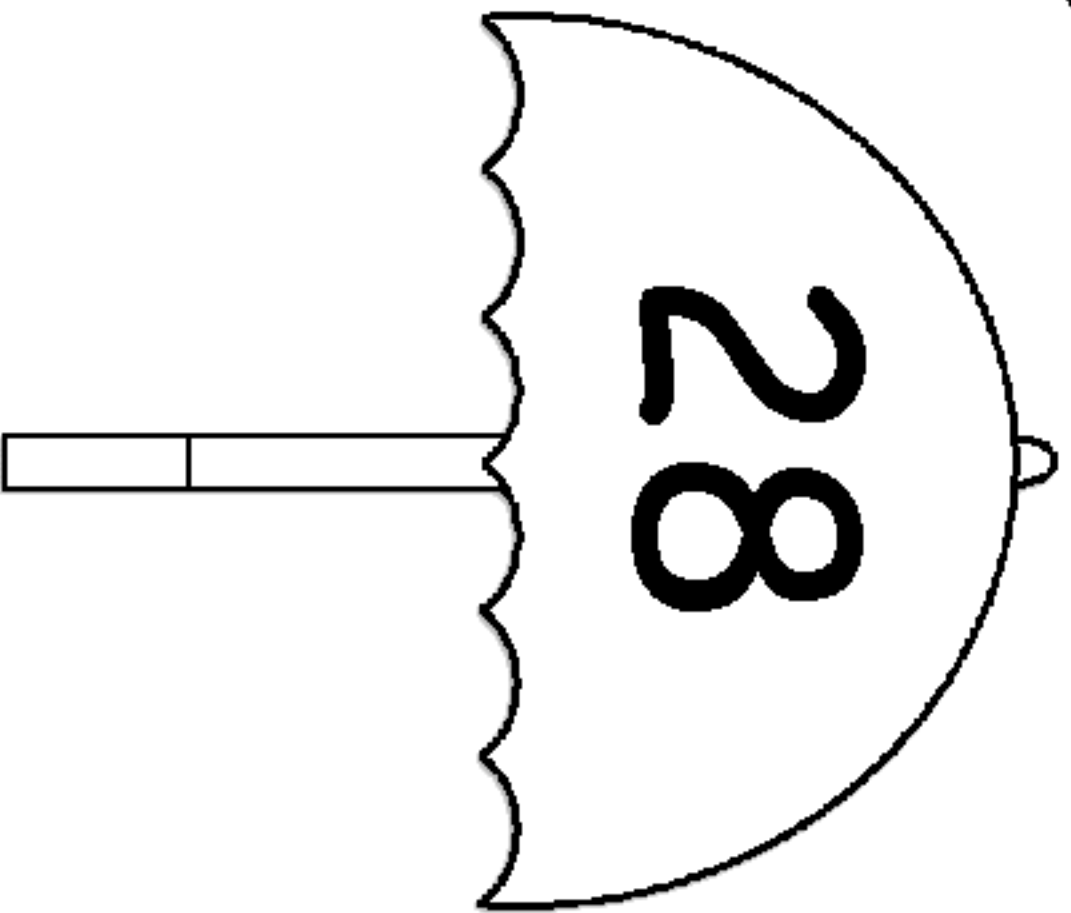

twenty eight

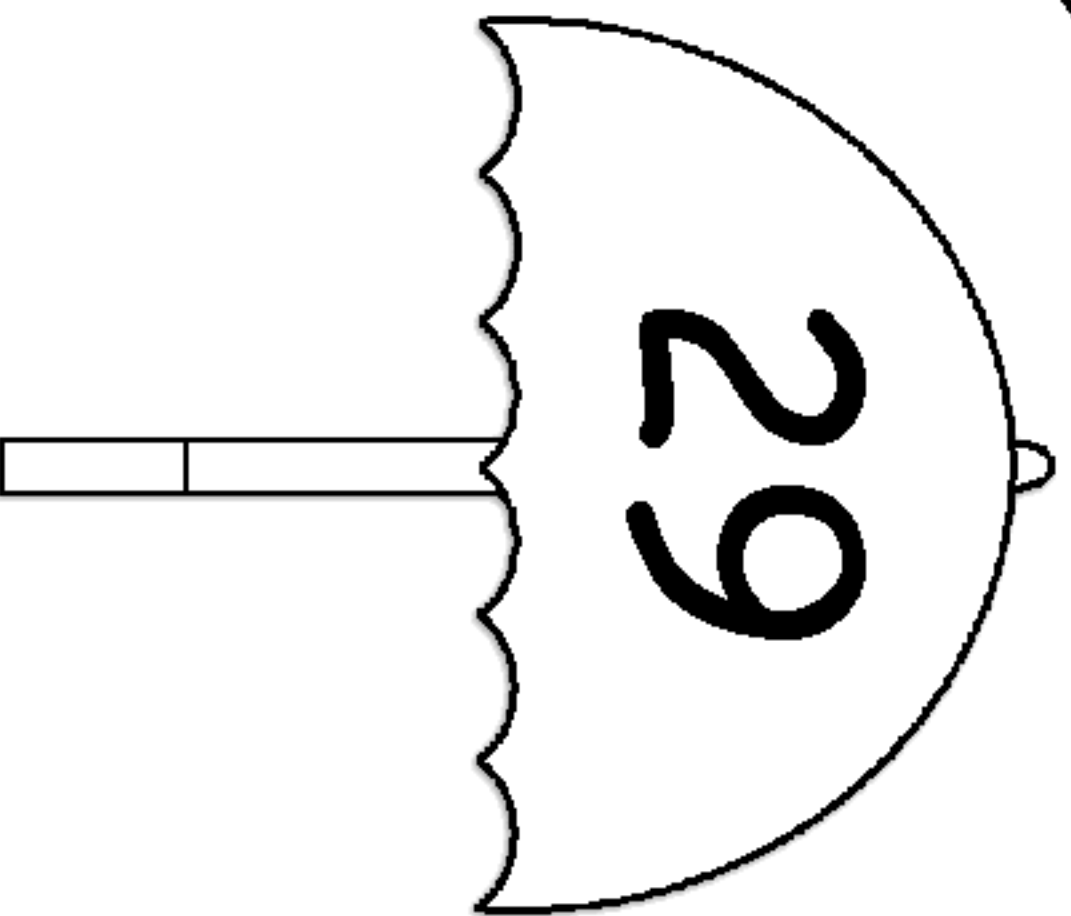

twenty nine

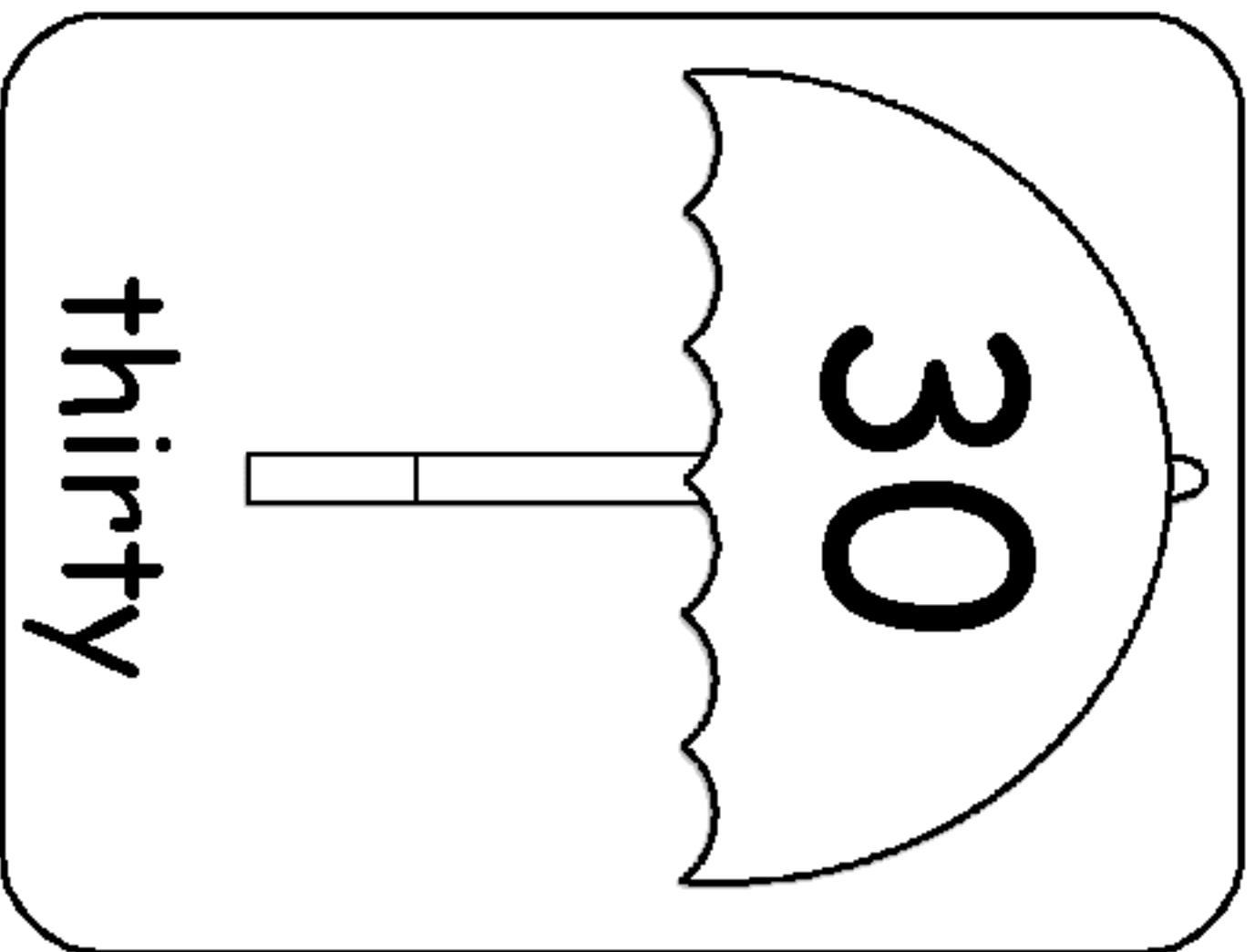

Umbrella Math Mats

Instructions: Print on Cardstock ... cut out and laminate. Children place the correct number of counters on each umbrella.

